

EN

INSTRUCTIONS
FOR USE

fence  Electric fencing



FENCE GATEWAY

DEVICE FOR REMOTE CENTRAL CONTROL AND MANAGEMENT OF ELECTRIC FENCE

Compatible

- fence **energy DUO RF EDX**
- fence **power DUO RF PDX**
- fence **Monitor MX10**

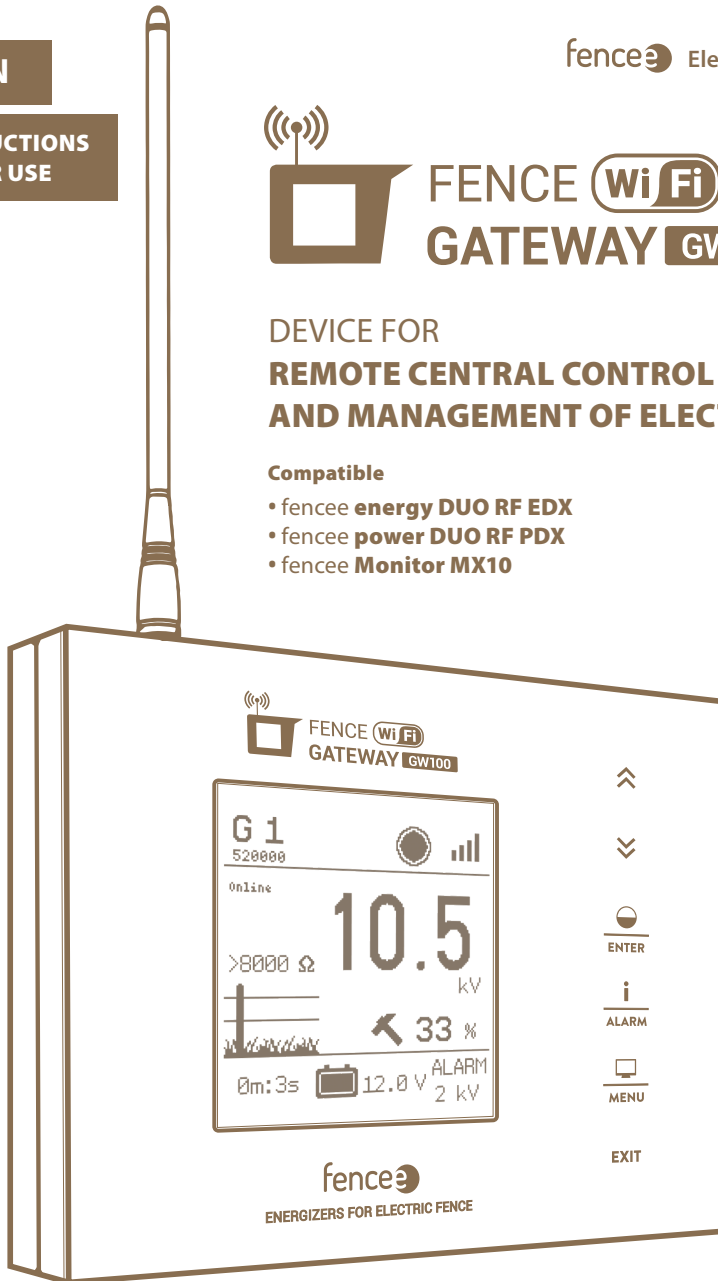

UP-TO-DATE INFORMATION

Online up-to-date information on all devices.



PHONE CONTROL

Control and monitor through mobile application.



ALARM SIGNALLING

Immediate problem alert sent to the phone and e-mail.

Thank you for purchasing this product
 fencee  **FENCE WiFi GATEWAY GW100** of the company VNT electronics s.r.o.

This device complies with the security regulations by the valid law same as for the appropriate EU (CE) regulation

The device complies with the EU directive **2014/53/EC**,
 Meets all requirements of General licence of the Czech telecommunications office by the general authorization
n. VO-R/10/05.2014-3, as well it complies with the requirements of norms which are listed below and to the
 relevant regulations for that kind of device:

ETSI EN 301 489-1 V1.9.2 | ETSI EN 301 489-3 V1.6.1 | ETSI EN 300 220-2 V.2.4.1
ETSI EN 60950-1 ed.2:2006 /A1:2010 /A11:2009 /A12:2011 /A2:2014/Opr.1:2012 EN 62479:2010
R&TTE EN300-220 a EN 61000-6-3:2007 + A1:2011
CSN EN 60335-1 | CSN EN 55014-1 | CSN EN 55014-2

1. CONTENT

1	Content	2
2	Important recommendations	3
3	Package content	3
4	Introduction	4
5	List of main advantages	5
6	Gateway installation and fence connection	6
7	Description of the device	8
	7.1 - Front side and operating touch keys	8
	7.2 - Back side	10
8	Ready to use	11
9	Device manager - pairing device	12
	9.1 - Pairing new device - energizer	12
	9.2 - Pairing new device - monitor	14
	9.3 - Subordinate monitor to the energizer	16
	9.4 - Editing device labels	17
	9.5 - Remove device	17
10	Overview screen	18
11	Detailed screen - energizer and monitor	20
12	Menu - setting of the device	21
	12.1 - Sound settings	21
	12.2 - Display settings	22
	12.3 - Advance settings	22
	12.4 - Device information	26
13	Wi-Fi connection	26
14	fencee Cloud application	30
15	Error reporting, signaling, deleting	31
16	Reset to factory settings	32
17	Possible sources of problems	32
18	Hole drilling template	33
19	Guarantee	35
20	Technical parameters	35

2. IMPORTANT RECOMMENDATIONS



We recommend that this manual is read thoroughly and fully understood before using the device and that it is retained for future reference!

- Only use the original 14 V/1 A adapter to supply the gateway. The supply voltage must not exceed 16 V.
- The gateway is not waterproof; ingress of water may irreparably damage it.
- Strictly observe all safety guidelines during installation work.
- The device may only be repaired by the manufacturer's qualified personnel.
- Please dispose all waste in accordance with your country's code of practice.
- **The displayed output voltage tolerance is $\pm 10\%$.**



To connect the gateway to Wi-Fi network, MAC address and PIN are required, which are given on the label attached to the back of this User Manual and in the product box. Keep this information safe as it may be used in the event of changes to the gateway configuration

3. PACKAGE CONTENTS

- FENCE WiFi GATEWAY GW100
- RF antenna
- 14 V/1 A power supply adapter for mains connection
- 9.6 V backup battery power supply
- 2 installation self-tapping screws and rawlplugs
- User Manual

4. INTRODUCTION

- FENCE WiFi GATEWAY GW100 enables remote central monitoring and control of the energizers and monitors. Up to twelve independent energizers or connected control devices, monitors MX10, may be controlled within the antenna range. The gateway gathers all information relating to the operation of all connected devices.
- All important information relating to the fence system is presented to the user in well-arranged format; the user has the option to set limit for triggering alarm for each fence and monitor, which will generate alert if the set limits are exceeded.
- Energizers may be remotely switched off, switched on, power output changed (50%/100%) and alarms set.
- It receives data relating to the fence system voltage from the monitor. The alarm limit may be set on the gateway and when it falls below the set limit, the alarm indicates status change.



Using Wi-Fi connection, the user has the ability to monitor and control all connected devices from mobile phone using the application or via web browser.

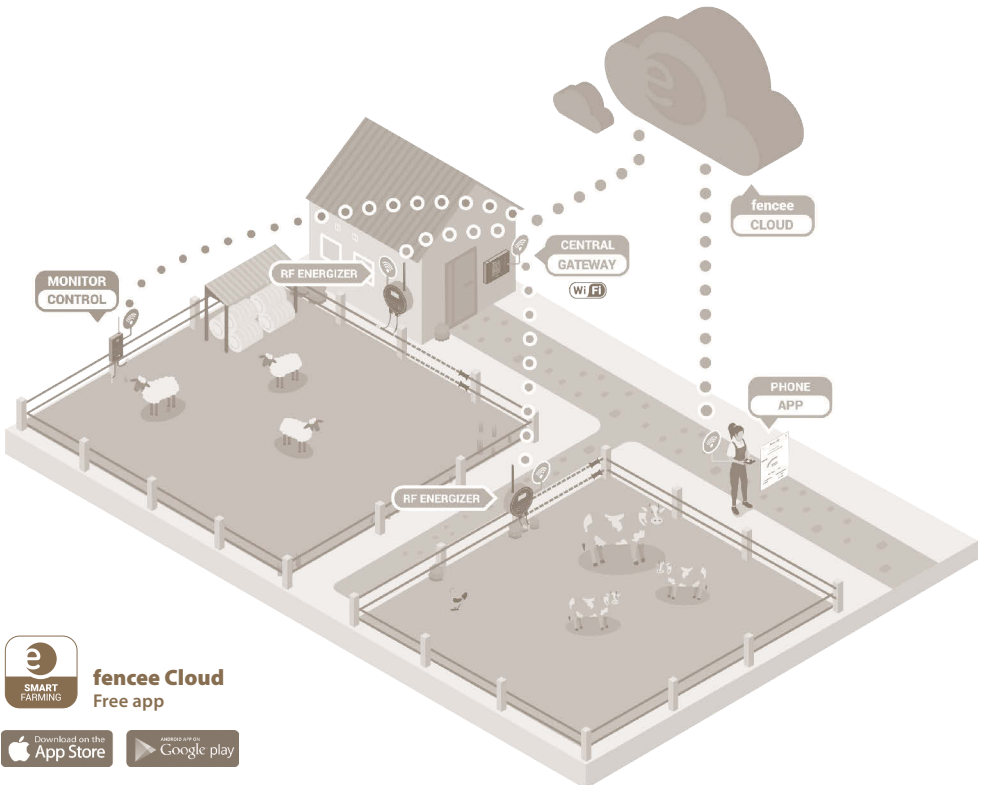

fence Cloud
Free app



5. LIST OF MAIN ADVANTAGES

- Online monitoring and control of connected devices from mobile phone using the application or via web browser
- Monitoring and control of up to 12 energizers and monitors
- Well-arranged, intuitive touch control
- Radio connection (RF) with energizers and monitors
- SIM card is not required
- All essential information together in one device
- Large, fully graphic LCD display
- Overview screen with information relating to all energizers and monitors
- Detailed display of parameters of each energizer and monitor
- Settable alarm limit for each connected device
- Mains supply + backup battery power supply
- Option to connect external warning system (siren, light)

Keep track with mobile application fencee Cloud

More on page 30

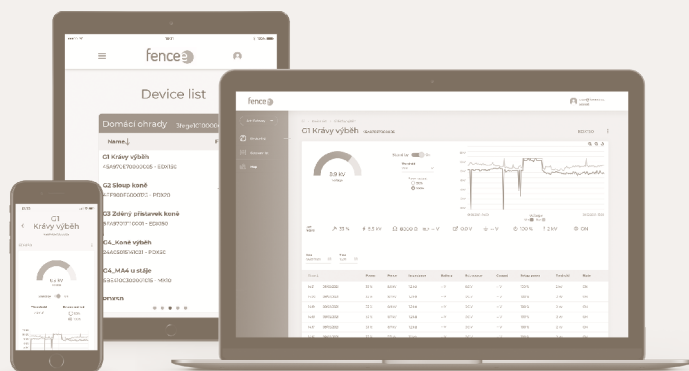

**WELL-ARRANGED
GRAPHS**



**LIST OF
DEVICES**



**ONLINE
ALARMS**



**MAP
BASE**



**TIME
SAVING**



**NO SIM CARD
NEEDED**

6. GATEWAY INSTALLATION AND FENCE CONNECTION

Before installing the gateway, please read all the security instructions in this manual carefully. For wall mounting, use the enclosed screws to easily hang the gateway.



Choose the right place where gateway is:

- The gateway is securely protected against water and moisture. **INCREASE OF WATER COULD CAUSE IRREVERSIBLE DAMAGE**
- Not exposed to direct sunlight.
- An electrical outlet (230V) is nearby.

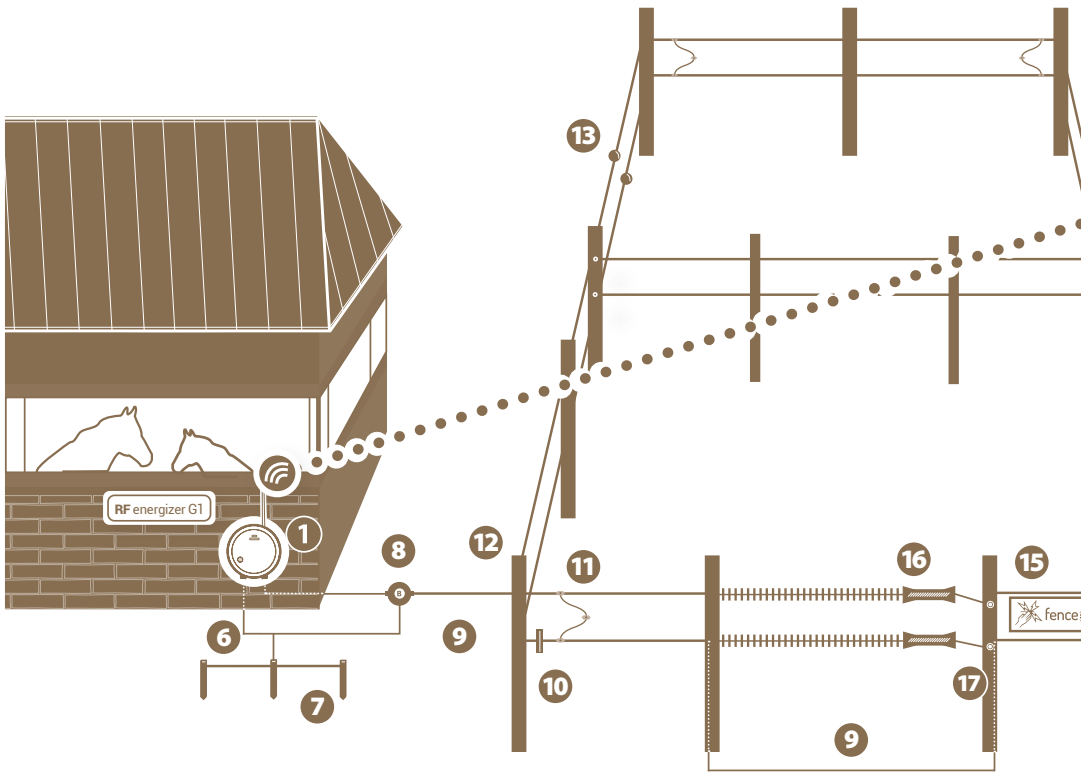

1	Energizer fence	5	External alarm with siren	9	High voltage connection cable
2	Gateway WiFi GW100	6	Earthing cable	10	Conductor
3	Monitor MX10	7	Anticorrosive earthing rod	11	Line connector
4	External RF antenna	8	Lightning diverter	12	Fixed post

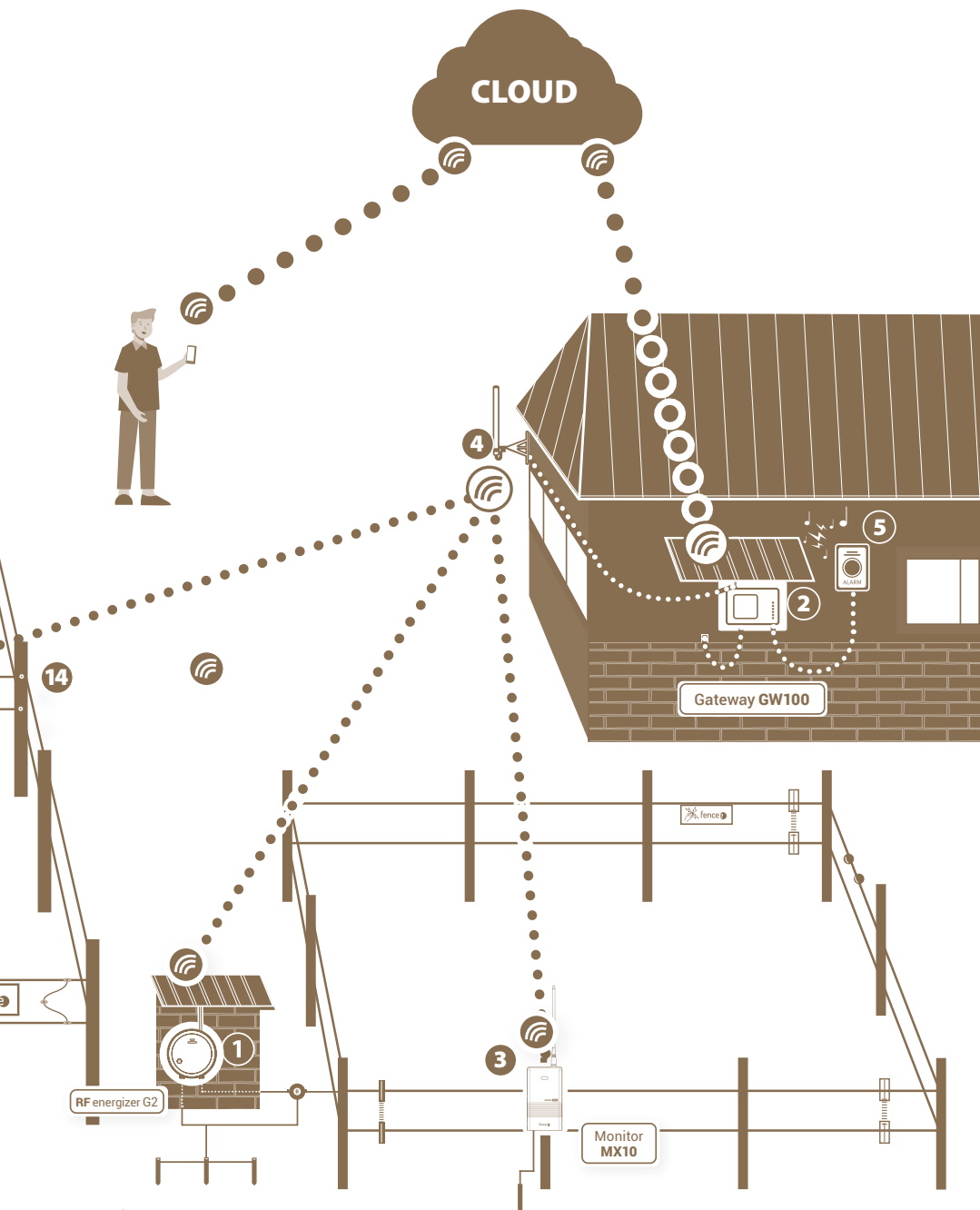

13 | Tensioner

14 | Insulators

15 | Warning sign

16 | Gate

17 | Insulator of gate

7. DESCRIPTION OF THE DEVICE

7.1 Front side and operating touch keys

The device can be operated using the touchpad shown.



THE DEVICE CAN DISTINGUISH TWO TYPES OF PRESS:

- Short press
- Long press (more than 1 s)

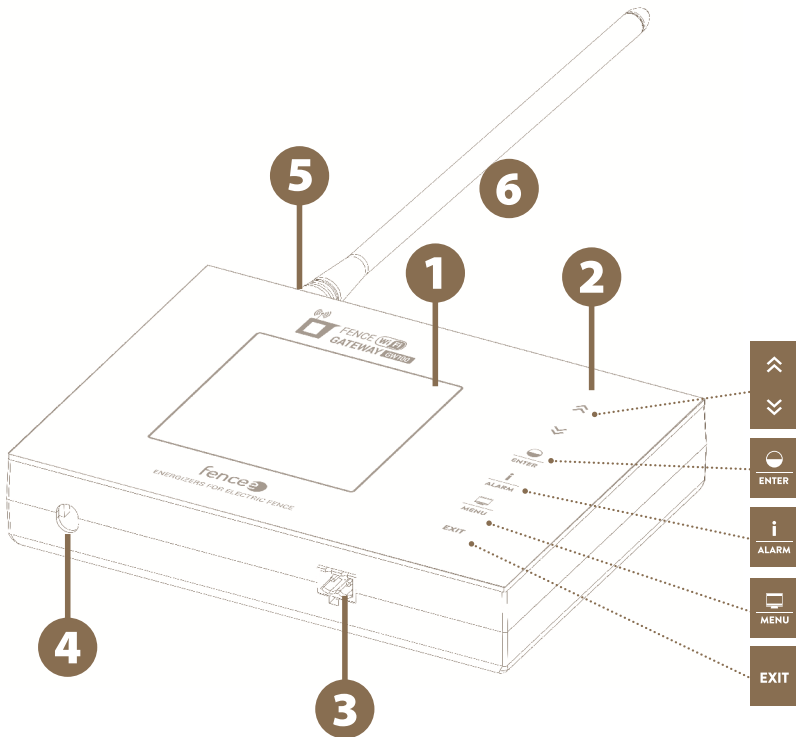

- 1** Graphic display with backlight
- 2** Touch control panel
- 3** Connector with relay, for external signaling
- 4** Power adapter connector
- 5** SMA connector for antenna connection
- 6** Radio RF antenna

KEYBOARD FUNCTION:



Screen	Functions
All	Device selection in detailed and overview screen. Changing values in setup mode, navigating through menus.



Overview and detailed screen	Short press - turns ON / turns OFF Long press - switching power (50 / 100 %) It does not work on the monitor
Menu and setting	Short press - confirm, enter to another screen. Long press - deleting of device from gateway.



Overview and detail screen	Short press - asking the selected device for up-to-date information. In case of error signaling, confirmation and deleting alerts. Long press - setting the pulse voltage limit If it falls below the set limit, the alarm is triggered.
-----------------------------------	--



Overview and detail screen	Short press - switch between detail and overview screen Long press - enter the menu
-----------------------------------	--



Overview and detailed screen	Long press - switch off gateway.
Menu	Short press - return to previous screen.
Switched off screen	Long press - switch on gateway.

7.2 Back side

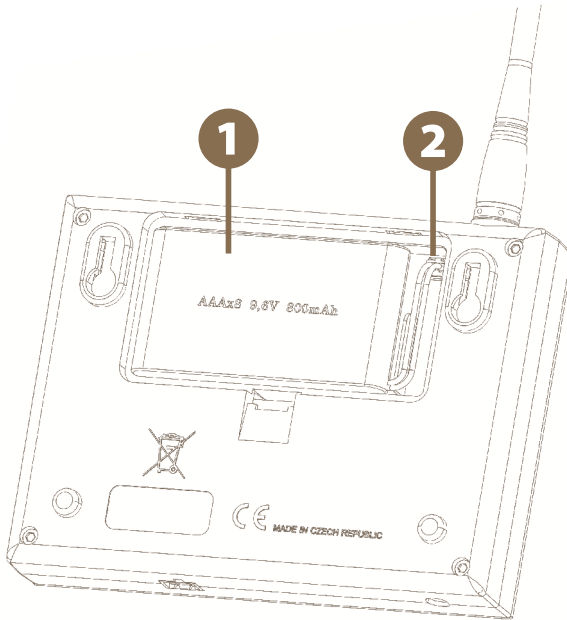

1 Backup battery

2 Socket for connecting the backup battery connector.

8. READY TO USE

Inserting backup battery

9.6 V backup battery power supply used in the event of mains power failure is able to supply the device for up to one day, however it depends on the device settings such as backlight or volume.

- Open the device back cover.
- Plug the backup battery connector into the socket.
- Insert the backup battery into the designated location and return the cover to its original position.

Connect the gateway to the mains using the power supply adapter.

Connect RF antenna to SMA connector.

Press and hold the touch key  to turn the gateway on.

WARNING:

Operating the device without mains power and only with very low battery charge may result in incorrect device operation!



Before commencing, connect the gateway to the mains, otherwise ECO Mode will start automatically (refer to Page 23) and the gateway will not be fully functional.

Main screen without connected devices



9. DEVICE MANAGER - PAIRING DEVICE

Device Manager is used for pairing, editing and deleting devices (energizers and monitors) in the gateway.

» Pairing Device - Pairing





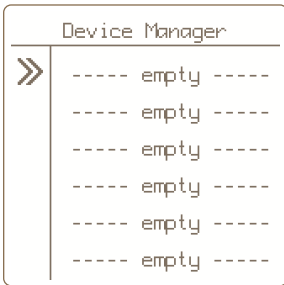

Pairing is the process of linking communication between two devices. The gateway GW100 can pair up to twelve different devices. The device can be renamed individually.

If all positions are occupied, it is not possible to start a new pairing!

9.1 Pairing new device - energizer

To select pairing, press and hold .



1. Use the arrows   to move to Pairing and by press the  key you will get to the Device Manager where you work with the device.
2. Switch the energizer to pairing mode - Switch on energizer and then switch it off with one short press. Then press and hold the button (> 5 seconds), until the LED flashes very quickly. Now is energizer in pairing mode. Place the device close to Gateway.
3. By arrows   move the cursor to an empty item "---- empty ----".
4. Short press of  key we confirm the chosen item.
5. The correct selection of the action is confirmed by the **Pairing new device** information screen.

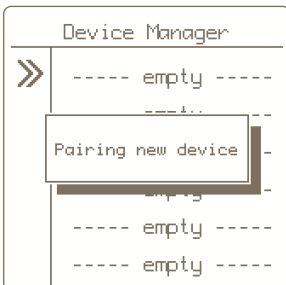

6. If pairing is successful, a menu is displayed for editing the displayed device.

7. Editing - for entering press  by arrows,   choose marking and confirm .

Optional designation: **1-12**

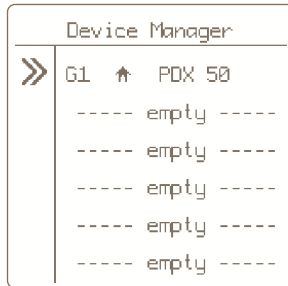
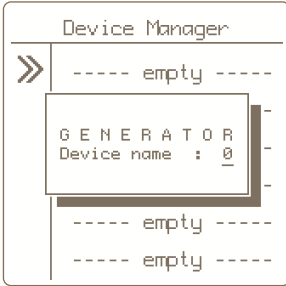

Only labels that have not yet been used are offered.



8. Press the button  to return to the main settings .

Remote Pairing

The gateway GW100 also enables remote pairing for energizers energy DUO RF EDX. This means that you do not have to have a energizer directly at the gateway to be able to pair it. Pairing can be performed over long distances using a code. Code activation in the EDX energizer is described in the EDX manual.

This choice you call by holding , you move on Pairing and confirm by press the key .



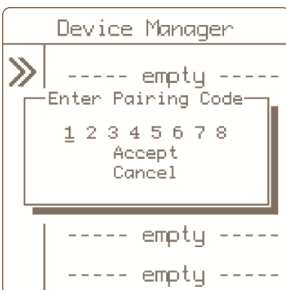

You will choose free position and by long press  you activate it. You input Code by

  and .



9.2 Pairing new device - monitor

To select pairing, press and hold .

1. Use the arrows   to move to Pairing and by press the  key you will get to the Device Manager where you work with the device.
2. Switch the monitor to pairing mode:
 - Switch off the monitor with a magnet, the LED flashes red.
 - Then reattach the magnet to the target on monitor and hold until both LEDs (green and red) flashes on the monitor.
 - The monitor is now in pairing mode.
 - Place the device close to the gateway.
3. By arrows   move the cursor to an empty item ----- empty -----

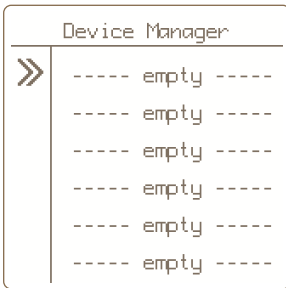

4. Short press of  key you confirm the chosen item.
5. The correct selection of the action is confirmed by the **Pairing new device** information screen.

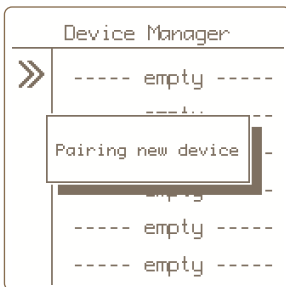



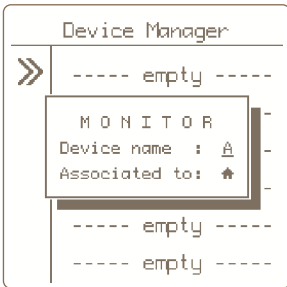

6. If pairing is successful, a menu is displayed for editing the displayed device.

Optional designation:

- **Device name:** **A - L** only a designation that is not yet used is offered.
- **Associated to:** see explanation on page 16 monitor Subordination.



7. Editing - for entering press , by arrows   choose marking and confirm .
8. Press the button  to return to the main settings .

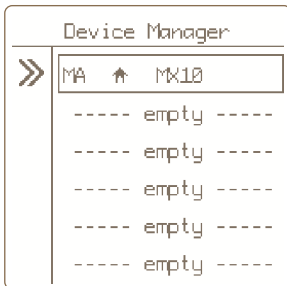







9.3. Subordinate monitor to the energizer

If you place one or more monitors on a fence powered by a specific energizer, we recommend that these monitors be subordinated to the energizer.

The main advantage is that if the energizer is intentionally switched off, no alarm is indicated on the monitors. And there is a better visual differences on the gateway display.



Procedure for setting subordination - in Device Manager:



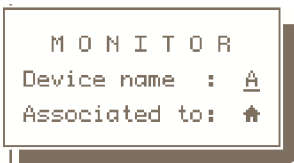



To select pairing, press and hold .

1. Use the arrows   to move to Pairing and by press the key  you will get to the Device manager where you work with the device.
2. Use the arrows   to move to desired item.
3. By short press key  you confirm choice of the monitor.
4. After confirmation, a pop-up window will appear showing the current settings.



5. Subordination is indicated on the line **Associated to:**

 house - monitor is independent, is not subordinate
 - monitor is subordinate to this energizer

6. If you want to change, use the arrows   to move to **Associated to.**
 7. By short press key  you confirm your choice.
 8. Editing is now signaled by flashing of the entered value, which can be changed to the desired name of the superior energizer with the arrows  .
- Note: values that cannot be selected are automatically skipped.
9. To confirm the change, shortly press the Enter  or  button.

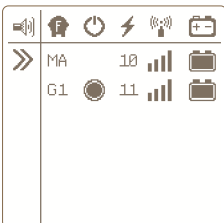

Overview screen with the independent monitor

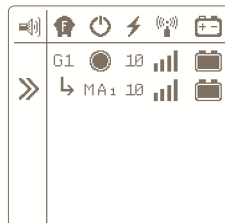











Overview screen with the subordinated monitor - to energizer G1

9.4 Editing device labels

Paired devices can be assigned a distinguishing sign.
Each device can only be assigned a name that is not yet in use.









To select editing, press and hold .

1. Use the arrows   to move to Pairing and by press the key  you will get to the Device manager where you work with the device.
2. Use the arrows   to move to desired item.
3. By short press  key you confirm choice of the item.
4. After confirmation, an information window appears showing the current settings.
5. The setting of the displayed marking is displayed by the **Device name item**.
6. By short press  key you confirm our choice.
7. Editing is now signaled by blinking of the entered value, which can be set by arrows  . Note: the values that you cannot choose are skipped automatically.
8. The change can be confirmed by short press of  key or by  key.

9.5 Remove device

To remove a device from the list of paired devices, follow the procedure below.

To remove the selection, press and hold the  key.

1. Use the arrows   to move to Pairing and press  key to manage the device.
2. Use the arrows   to move to desired item.
3. Long press the  key to enter the delete menu.
4. Correct selection of the action is confirmed by pop-up window with DELETE + the name of the selected device.
5. Use the arrows   to select the option **Yes** to select delete, **Cancel** to deleting.

Note: You can also cancel by pressing the  key.

6. By short press of the  key you confirm selected action.

10. OVERVIEW SCREEN

The screen provides an immediate overview of all connected devices.

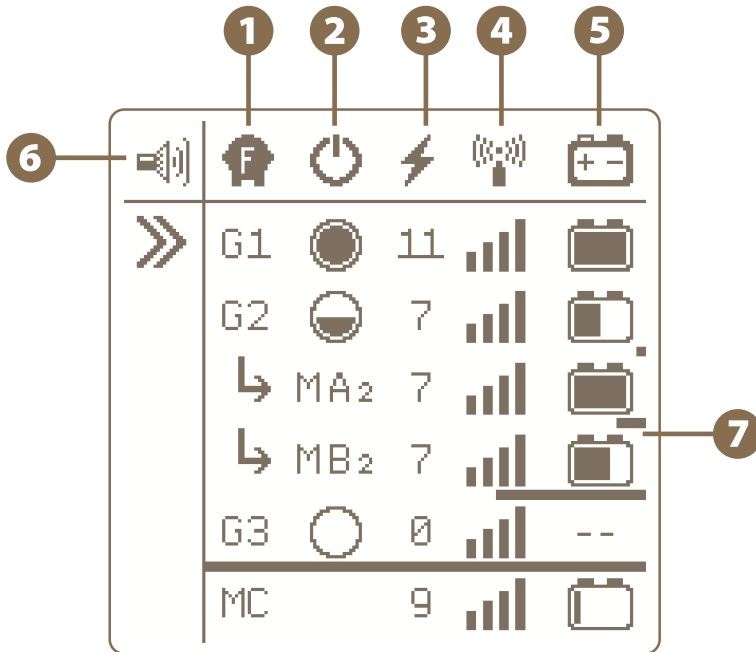

1 [Generator] Type of device

GX or MX marking

- **G** indicates a generator device (energizer)
- **M** indicates a monitor device
- **X** indicates optional name to distinguish between energizers **1 - 12** or monitors **A - L**
- **The monitor can be installed subordinate to the energizer** - see ↳ MA₂ ↳ MB₂
Subordination means that the monitor check the same fence where the voltage is being generated by superior energizer. If the fence is intentionally switched off, no recall occurs alarm on the monitor. In the case of subordinate monitor, the designation is supplemented by a name of superior energizers (in this case G2, ie the designation of monitor MA2, MB2).
- **Or the monitor can be installed separately, independent of the energizer** - see MC
- Energizers or monitors with identical names cannot be operated on the gateway.

2 ⏻ Energizer state and its power



• **power 0%** - energizer is off, the device communicates (in standby mode)
see energizer G3



• **power 50%** - the energizer is switched on and set to half power
see energizer G2



• **power 100%** - the energizer is turned on and set to full power
see energizer G1



• **energizer is completely switched off** and does not communicate.
This status is not indicated for the monitor.

3 ⚡ Last measured voltage at the fence [kV]

4 📶 Signal level of the connected energizer

5 🔋 Displays the battery status when is connected to energizer or displays status of monitor's battery

6 🔊 Indication of activation of the audible alarm - see page 21

7 ⏱ Indication of last device response

Under each device is a bargraph, which signals the time since the last sent information about the status of the remote device. The transmission interval between the energizer and the gateway is each minute, between the monitor and the gateway every 15 minutes. The bargraph is displayed from 2 minutes since the last transmission. If the entire device is underlined, an alarm is set automatically. If at any time during the transmission with information about the device, the bargraph is zeroed and starts to be timed again.

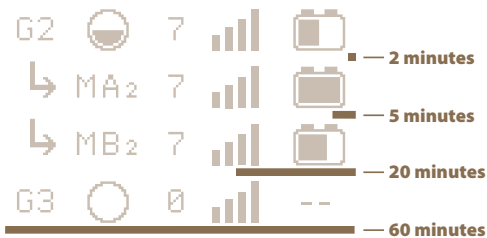

11. DETAILED SCREEN - ENERGIZER AND MONITOR

Detailed screen is used to show all the possible information about concrete device.

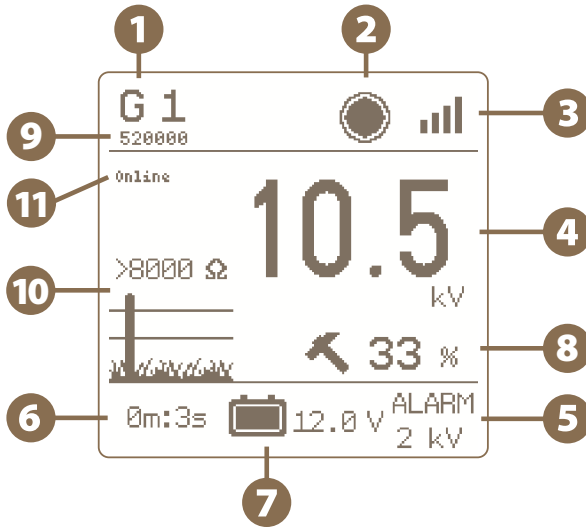

- 1 The name of device** (possibility to change by user)
There is displayed MAC address of the connected device under the name.
- 2 Energizer state and its power**
This status is not indicated for the monitor.
- 3 Signal level between device and gateway**
- 4 The value of the voltage on the fence [kV]**
- 5 Current alarm value [kV]**
- 6 The time since the last information received from the device**
- 7 Battery voltage status when connected to energizer [V]
Or battery status of the monitor [%]**
- 8 Energizer's performance according to the current load (impedance) of the fence system.** Only for EDX series energizers.
- 9 MAC address fo device** (energizer, monitor)
- 10 Current load (impedance) of the fence, displayed in Ohms (the lower the number, the more loaded the fence) and a symbolic graphic expression.**
Only for EDX series energizers.
- 11 Gateway to Wi-Fi connection status**
online – the gateway is connected and communicates with Wi-Fi
conn. Wifi – gateway is not connected to Wi-Fi, for communication is necessary to configure WIFI connection

12. MENU - SETTING OF THE DEVICE

To enter the menu, press and hold the key  from an overview or detailed screen.



Use the arrows   to move the cursor and you can get inside by short press of key .

To exit the menu, press shortly the key .

12.1 Sound settings - Sounds

Sound setting gateway.

- » Buttons Clicks - The volume of the buttons is adjustable in four levels (off, level 1, 2 and 3).
- » Alarm Sounds - Enable audible alarms on the gateway (ON / OFF).

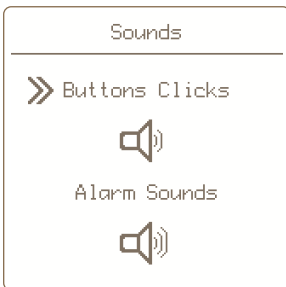

Use the arrows   to move between options, change it by pressing .

12.2 Display settings - Display

- Contrast:** Contrast setting (-50 to +50); negative values invert the display colours into so-called Night Mode
- Brightness:** Backlight intensity setting 0% to 100% is active only if backlighting is enabled (refer to Backlight)
- Backlight:** Enabling the display backlighting On or Off
- Auto Off:** Setting the time for the backlight to turn off automatically from the last key press; selectable from 5 to 55 seconds or Never (by a letter on the display) for the constant backlight

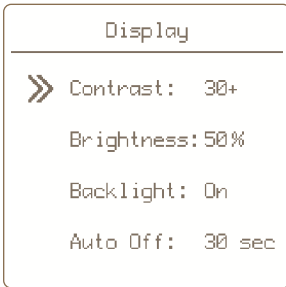





Procedure for setting the gateway display:

Select parameter by using   by pressing  is enabled and by using arrows values are changed. Subsequently press .

12.3 Advance settings - Advanced Setup

The user has the option of advanced settings of gateway functions.

Hold down the keys    enable the selection, then the Advanced Setup screen appears, press .

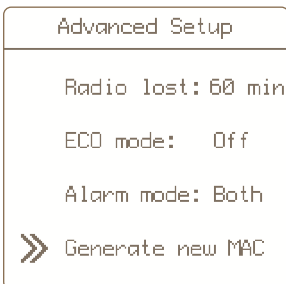



» Radio lost: 60 min

The user has the option to set up signal transmission control between the gateway and paired devices at set intervals. 60 min is set for all devices by default. The user is able to set shorter intervals in order to be notified of a signal failure earlier.

Interval options: 15 min • 30 min • 45 min • 60 min

Setting procedure:

Select Radio lost by using   press .

By using   select the required interval; press .

Exit by pressing key. .

» ECO mode: On

In the event of a power failure, the ECO Mode function adjusts the gateway operating mode to consume less energy.

This means that:

- Display backlight is set to 5%
- Display backlight turns off 5 seconds after the last key press
- Acoustic alarm has a longer pause between sounds

Setting procedure:

Select ECO Mode by using   press .

By using   switch between ON or OFF; press .

Exit by pressing .

When the electricity supply is restored, everything will return to the original values; this feature is enabled by default.



» Alarm mode: Both

The user also has the option to select the following type of alarm:

- **Sound only** – Alarm will be signalled by a siren integrated into the gateway
- **Relay only** – Alarm will be signalled by closing the output relay and triggering the connected external alarm
- **Both** – Both of the abovementioned alarms will be activated

Option Both is set by default.

Setting procedure:

Select Alarm by using   press .

By using   select the required alarm option; press .

Exit by pressing key .

» Generate new MAC

MAC address and security PIN are unique codes for the given gateway by which the gateway is able to connect to the Cloud application and thus to the mobile application and web browser. This option changes the current gateway MAC address. This function will be used particularly when the GW100 gateway is bought from another user. Changing the MAC address will ensure that all previously connected devices are disconnected from the gateway.

To activate the function, the current MAC address and PIN must be known (factory original is listed in the box with the product and on the label attached to the back of this manual).

If the MAC address has already changed using this option, then the generated MAC address and PIN must be known.



FUNCTION IS IRREVERSIBLE!

If change of MAC address is confirmed (by pressing the Accept key after entering the PIN) then the change will take place and all devices will be disconnected.







Setting procedure:

Selection of pairing is called up by holding down .

By using   select Advanced Set up; press .

By using   select Generate new MAC and press .

Enter pin to gateway screen appears.

By using   move to the individual positions one by one, press  and by using   the correct character; always confirm by pressing .

When the correct PIN is set, by using   select Accept key and press .



If incorrect PIN has been entered, then the Wrong Pin pop-up window will appear briefly and the entire procedure must be repeated. If everything has been carried out correctly, the MAC address will be overwritten in the gateway's memory and new PIN will be generated. Both data are displayed on the screen.

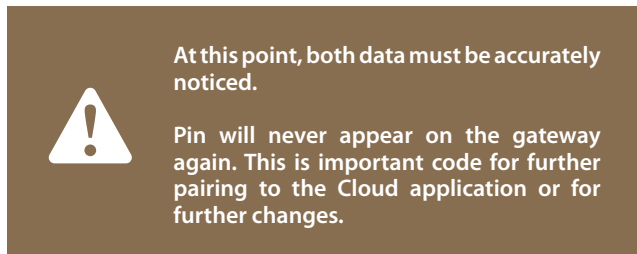

This screen must be confirmed by long press of the Enter key to prevent accidental exit from the screen.

After changing the MAC address, the gateway is disconnected from the Cloud application. The gateway restarts and the change is complete. The new MAC address is visible on the screen immediately after starting the gateway.

12.4 Device information - About



It displays system information (manufacturer, firmware version, backup battery and power supply adapter voltage).

13. Wi-Fi CONNECTION

Mobile phone with Internet connection that is capable reading the QR code with the camera or with application for reading QR codes is required. GW100 installation site must have good Wi-Fi cover.



1. Wi-Fi module settings

By holding down displayed on the overview or detail screen selection appears.

By using select WiFi Setup, press .

2. In order to create a new connection, the SSID line must be blank; if yes then proceed as per

Point 3 If no, using select Reset SSID line in the pop-up window,

then using select Yes and press . In approximately 10 to 15 seconds, the Reset SSID line will change to Configure WiFi and the SSID line will be blank.

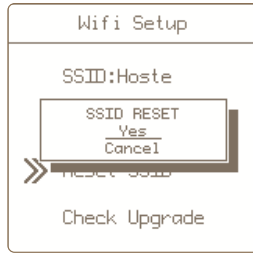

3. Enabling Wi-Fi Configuration Mode

This is GW100 main screen ready for Wi-Fi connection.

Using   select Configure WiFi and press .



4. GW100 will display Activating config mode message and the QR code will appear with designation WiFi connect. Scan the displayed QR Code with your mobile phone.

 Code may also be scanned here.



Confirm the Wi-Fi login information named „gateway“ on your mobile phone. This generates connection in the phone, even if the Internet is not available, which takes up to 10 seconds. **If the QR code cannot be scanned, it is possible to login manually. View the available Wi-Fi list on your phone, select „gateway“, the login password is „administrator“.**

5. The next step is to connect to the gateway website. Press  the second QR code will appear, named Open Page. Re-enter the QR code on your mobile phone. Confirm login to Wi-Fi in the phone (Open link) – IP address 92.168.4.1.

 Code may also be scanned here.



If the QR code cannot be scanned, it is possible to log in manually. Turn on any web browser on your phone and manually type the IP address into the address (search bar): **192.168.4.1**. List of available Wi-Fi will appear and then proceed as per Point 6.

6. Select the appropriate Wi-Fi in the web browser and login by entering the correct password.







7. If all is correct, the GW100 will close the QR code window within approximately 15 seconds. The SSID line will display the name of the connected Wi-Fi and the second line will display WS Ready.



It is also possible to turn off the browser on the mobile phone; this page is already disconnected from GW100.

Comment:

- If the connection is not enabled after 15 seconds, try again. Using   select Stop WiFi Config and press  Config mode stopped message appears on GW100; subsequently proceed as per Point 3.
- Configuration process may be stopped at any time by pressing  .

Your device may now be activated and managed on the web browser or in the mobile application. For this, MAC address and Pin, unique codes for your GW100 device, are required. These may be found in the package contents (label on the back of this manual and in the product box). This information must be kept safe for the next login of the gateway to another user account or for any configuration change.

14. fence Cloud APPLICATION

- Keeping track of and check over the devices connected to GW100
- Device may be turn on and off remotely as well as changing power output
- Option to set voltage limit when the alarm is triggered
- Alarm record for each device
- Measured values are displayed in graph format
- Graph showing the course of measured values over the timeline
- Location within the map background and quick click-through to a specific device

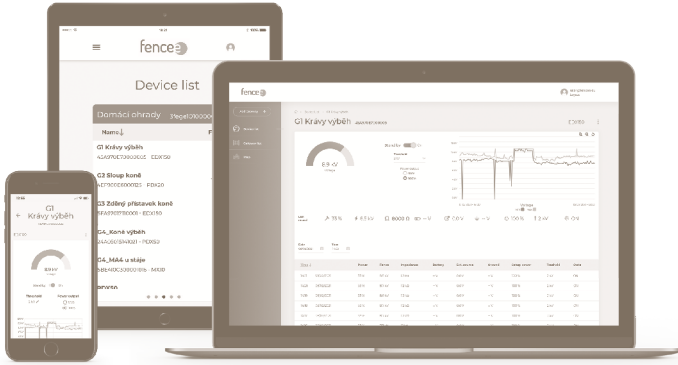

WELL-ARRANGED GRAPHS

Graphs showing the course of measured values over the last 7 days.



LIST OF DEVICES

Well-arranged lists of all connected devices, displayed according to the parent gateway.



ONLINE ALARMS

In the event that exceptional/fault condition arises, immediate warning is sent to the phone and e-mail.



MAP BASE

For easy orientation within the Smart Farm, the device shown on the map may be tracked to a specific position. Then, by clicking on the map a specific device may be reached.



TIME SAVING

Using remote control means that walk around the fence system is no longer required. All is monitored and controlled from the phone or web site.



NO SIM CARD NEEDED

No additional equipment operating costs



LOGIN VIA WEB BROWSER: www.fencecloud.com

Login using e-mail account and then register the gateway using MAC address.



fence Cloud
Free app



15. ERROR REPORTING, SIGNALING, DELETING

Each connected device reports its alarms directly to the gateway. These errors may be with the following signaling:

Low battery

- Battery connected to an energizer - the battery symbol flashes when the voltage drops below 12 V. In addition, if the voltage drops below 11.6 V, the siren will sound (if sound is enabled, see page 21).
- Battery of the monitor - an alarm is indicated when the voltage of the battery drops below 10%.
- **Decrease of the output voltage from the energizer or decrease of the voltage at the measured point by monitor below the set limit** – the symbol with kV will flash and the siren will sound (if it is allowed sound, see page 21).
- **Signal Loss** – Dashes are displayed instead of all energizer's or monitor's values and the signal level symbol flashes and the siren sounds (if sound is enabled, see page 21).

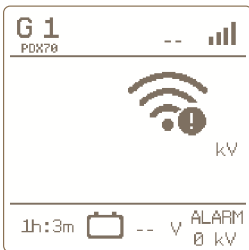

» Signaling

If any of these errors occur, the gateway signals the fault as follows:

1. The information that indicates the error flashes on the gateway display.
2. The output relay closes. It causes that external alarm is activated, if is connected and set (see page 24, Alarm mode)
3. If audible alarms are enabled, the siren will sound (see page 21 for sound settings  and Alarm mode set, see page 24).

» Confirming and deleting errors

The alert will be activated until acknowledged by the user.

- Deactivating the audible alarm and opening the output relay can be done by pressing any key.
- To completely clear gateway errors (error segments blinking), press the  key.
- Subsequently, the gateway will update the information and if a device fault is still detected, the alarm is reactivated.
- If the fault is remedied, the error symbol stops flashing, an audible alarm, and an output relay are deactivated.



16. RESET TO FACTORY SETTINGS

Resetting includes:

- Deleting all paired devices.
- Formatting empty positions.
- Resetting the display contrast and backlight settings.
- Resetting the sound settings.

If necessary, reset the gateway to the factory settings follow those instructions:

To select resetting, press and hold .

1. Use the arrows   to move to About and confirm by press .

2. By long press  you activate your choice.

3. Correct selection of the action is confirmed by pop-up window with **FACTORY RESET**.

4. Use the arrows   to select the option **Yes** to select delete, **Cancel** to deleting.

Note: You can also cancel by pressing the  key.

5. By short press of the  key you confirm selected action.

17. POSSIBLE SOURCES OF PROBLEMS

Cause	Troubleshooting
Pairing failed to complete.	The surroundings are heavily disturbed, or the signal between the gateway and the paired device is too weak. Pair the device with antennas closer to each other or in a less disturbed environment.
Nothing is visible on the display.	Check the power supply. In the event of a battery failure, check the battery condition.
Unreadable display.	The device has been exposed to the temperature extreme, change the contrast in the settings.
The device displays non-existent energizers.	The device operated on low voltage only from the battery. Replace the battery and reset to factory settings, see manual.

18. HOLE DRILLING TEMPLATE

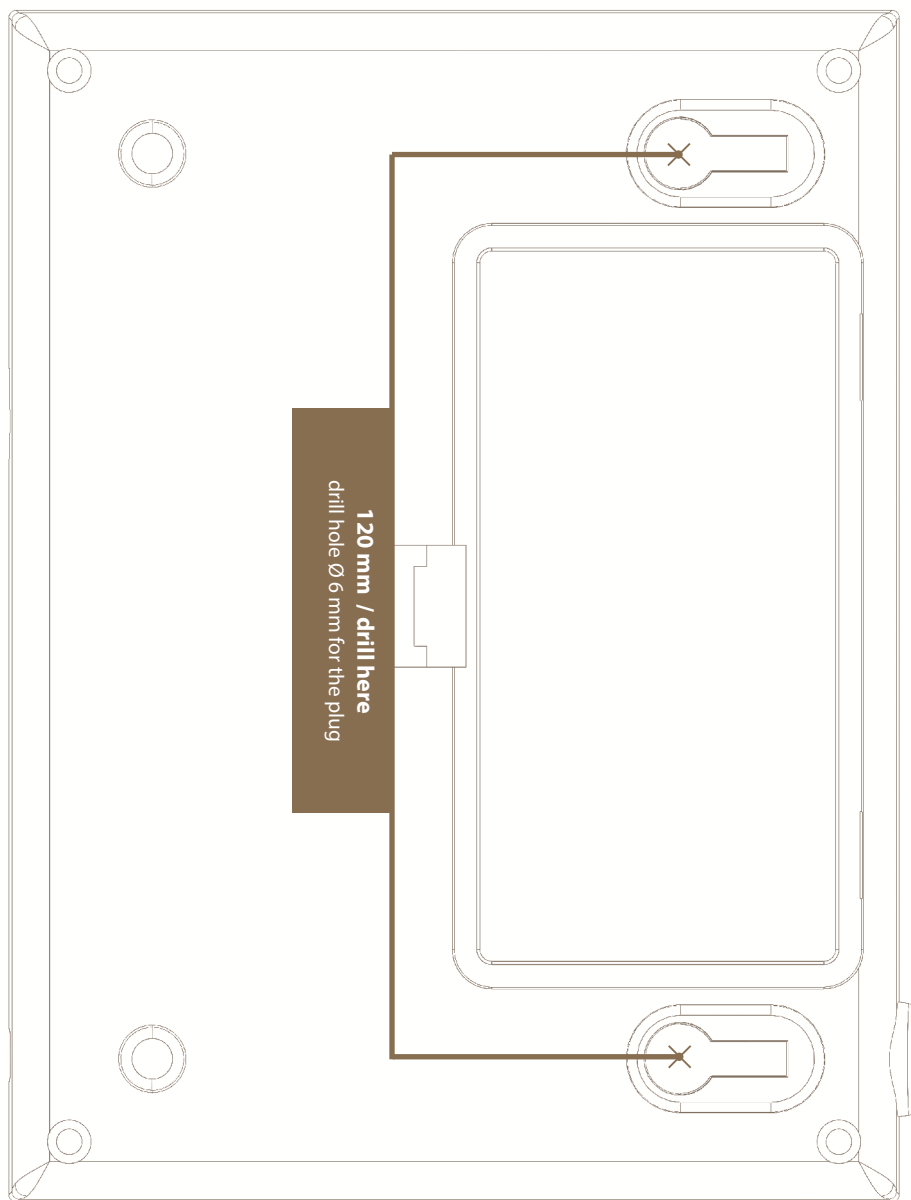

19. GUARANTEE

In addition to a guarantee requested by law, we provide you with a guarantee in accordance with below listed conditions:

- Guarantee period begins on the day of its purchase. Guarantee claims are acknowledged explicitly pursuant to submission of bill or cash voucher. Guarantee repair is free of charge, or we reserve the right to deliver a device of the same value.
- Guarantee is valid in case of correct use in accordance with the instructions for use. It expires in case of interferences by unauthorized persons and in case of using spare parts of foreign origin.
- All deficiencies resulting from material defects or manufacturing defects shall be removed in manufacturer's discretion by repairing or free-of-charge replacement of the device.
- In case of delivering spare parts or repairing, original guarantee period is not prolonged.
- Guarantee period and address of guarantee provider can be found in attached instructions for use of given type of device.
- Accumulators or batteries of any type, damages due to overvoltage (caused by lightning among others) and damages due to spill-over of accumulator acid are not included in the guarantee.

This device is provided with guarantee period of 3 years according to our conditions for guarantee! Safety instructions, putting into operation, care of batteries and accumulator, conditions for guarantee and possible fault sources can be found in attached instructions for use!

20. TECHNICAL PARAMETERS

- Range between gateway and device with basic antenna is up to 10 km (included)
- Possibility to connect an external antenna - increase range up to 30 km (2 or 10 m extension cable)
- Power adapter 230 V / 50 Hz, 14 V DC
- Maximum consumption 300 mA
- Backup battery 9.6 V 800 mAh - automatic charging
- Transmission frequency RF - 869.525 MHz / 22 dBm
- Switching contact relay for external alarm system - max. 60 V DC
- Dimensions 165 x 116 x 35 mm
- Weight 420 g

fencee



06052021

MAC + PIN

Stamp and signature of seller:

fencee Electric **fencing**

VNT electronics s.r.o.

Dvorska 605, 563 01 Lanskroutn, Czech Republic
info@fencee.eu

+420 730 893 828

Servis: +420 730 893 827

f fencee.cz @ fenceeczech



fencee Cloud
Free app



www.fencee.eu
www.fenceefarm.com
www.fenceecloud.com